

HAKI Komponentlista SE

Innehåll

HAKI UNIVERSAL	3
HAKI UNIVERSAL AL	21
HAKI UNIVERSAL S6 AL	24
HAKI UNIVERSAL APPLIKATIONER	26
HAKI RAM	35
HAKI RAM AL	38
RÖR & KOPPLING	40
HAKITEC 450 VÄDERSKYDD	41
HAKITEC 750 VÄDERSKYDD	43
HAKIITEC 750 TKS VÄDERSKYDD	48
HAKITEC INKLÄDNAD	50
ÖVRIGT SORTIMENT	52

Försäljningsvillkor

Priserna gäller exklusive mervärdesskatt och fritt fabrik, Sverige.

I övrigt gäller våra Allmänna leveransbestämmelser.

Reservation för prisändringar.

OBS!

1) Om hyrestagare ej gjort anmärkning inom 8 dagar efter hyresmaterialets emottagande betraktas detta levererat och godkänt enligt hyresavtalet.

2) Material som märkts(målats) av kund återtas ej.

Allmänna leveransbestämmelser

Allmänna leveransbestämmelser NL 17 gäller med följande undantag, tillägg och förtydliganden:

a) Dröjsmålsränta debiteras med referensränta + 8 %.















b) Levererat material förblir i enlighet med 20 p NL 17 HAKI AB's egendom till dess full betalning erlagts. HAKI AB har rätt att återta levererat material som köparen inte betalat i tid. Köparen svarar för samtliga kostnader i samband med återtagandet.

c) I 23 p NL 17 är ansvarstiden utsträckt till två år vad beträffar ställningsmaterial.



d) HAKI AB's ansvar omfattar inte skador som uppstår till följd av felaktig eller oriktig användning eller montering av produkten. HAKI AB ansvarar ej för skada till följd av driftavbrott eller annan skada som drabbar tredje man.

e) Köparen samtycker genom godkännande av offerten till att HAKI AB uppfyller de förpliktelser som framgår av 4 p NL 17 genom att göra dokumentation tillgänglig via Internet.





HAKI Färgkod

564		1050		1964		2500	
700		1250		2050		2550	
770		1550		2210		3050	
1010		1655		2357			





			Utför.	Art. nr	Vikt
Bottenskruv - Fzv		BS	G	2071000	5,0
Justerbar BS=55-570 mm					
Bottenskruv ledad 750 -Fzv			G	2071005	5,9
Justerbar bottenplatta 150x150 mm Justerbar 85-585 mm					
Låsfjäder bottenskruv - Fzv			G	2071100	0,17
Håller bottenskruv på plats vid lyft av ställningssektion					

Spiror



			Utför.	Art. nr	Vikt
Spira S Fzv		S 500	G	7016050	2,9
Spirskarv med tapp Ø 38 mm		S 1000	G	7016100	5,3
Rördiameter 48 mm		S 1500	G	7016150	7,7
		S 2000	G	7016200	10,1
		S 3000	G	7016300	15,2
Toppspira SC - Fzv		SC 353	G	7011004	2,0
Rördiameter 48 mm		SC 853	G	7011104	4,8
		SC1353	G	7011154	7,3
		SC1853	G	7011204	9,8
Sprint till spirskarv - Fzv		Låssprint fjäder 16	G	2116000	0,17
Diameter 16 mm För förstärkning av spirskarv vid draglast t ex vid hängande ställning, lyft eller ställning för väderskyddstak		Sprint med länk	G	5141257	0,3
Bygelkoppling 48 - Fzv		Kpl.48	G	2048017	1,4





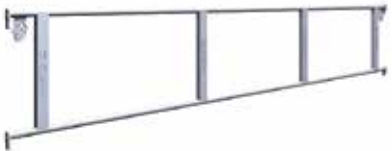

Horisontaler

			Utför.	Art. nr	Vikt
Längdbalk - Fzv		1050	G	7021102	4,8
Med fjäderlås		1250	G	7021122	6,5
Rördiameter 34 mm		1525	G	7021151	7,0
		1550	G	7021152	6,6
		1655	G	7021162	6,7
		1964	G	7021192	8,0
		2050	G	7021202	8,5
		2500	G	7021252	10,9
		2550	G	7021257	11,2
		3050	G	7021302	12,3

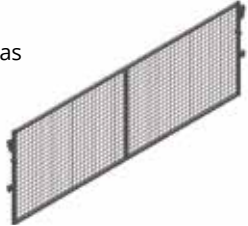
		Utför.	Art. nr	Vikt
Enrörsbalk - Fzv	564	G	7022050	3,6
Med fjäderlås	700	G	7022066	3,3
Rördiameter 48 mm	770	G	7022073	3,6
	1010	G	7022097	4,3
	1050	G	7022101	4,4
	1250	G	7022121	5,1
	1525	G	7022151	6,2
	1550	G	7022153	6,2
	1655	G	7022161	6,3
	1964	G	7022191	7,3
	2050	G	7022201	7,8
	2500	G	7022246	9,9
	2550	G	7022253	9,7
	3050	G	7022301	11,3

Skyddsräcken







		Utför.	Art. nr	Vikt
Skyddsräcksram GFL -Fzv	564	G	7052056	3,1
Med fjäderlås	700	G	7052070	3,8
Rör oktagon 28 mm	770	G	7052077	4,0
	1010	G	7052104	4,8
	1050	G	7052106	4,9
	1250	G	7052124	5,7
	1525	G	7052151	6,4
	1550	G	7052154	6,6
	1655	G	7052164	7,4
	1964	G	7052194	8,1
	2050	G	7052204	8,2
	2500	G	7052254	9,2
	2550	G	7052255	9,3
	3050	G	7052304	10,5
Skyddsräcksram för trätrall GFLH -Fzv	700	G	7052071	3,9
Med fjäderlås	770	G	7052076	4,1
Förhöjd 26 mm	1050	G	7052108	5,0
- Vid spiror med byglar på samme nivå och inplankning med trall	1250	G	7052125	5,8
	1525	G	7052152	6,5
- För längdbalksled vid spiror med byglar på olika nivåer och inplankning med trall	1550	G	7052155	6,7
	1655	G	7052165	7,5
	1964	G	7052195	8,2
	2050	G	7052205	8,3
	2500	G	7052250	9,3
	2550	G	7052256	9,4
	3050	G	7052305	11,5





		Utför.	Art.nr.	Vikt
Skyddsgrind med nät SGF - Fzv	1050	G	7055101	13,3
Steglöst justerbar 118 mm	1250	G	7055121	14,6
i höjd för att kunna anpassas	1655	G	7055161	17,0
till olika inplankningar	1964	G	7055191	19,4
Nyckelvidd 22 mm	2050	G	7055205	20,0
	2500	G	7055250	23,2
	2550	G	7055251	24,0
	3050	G	7055300	26,8
				
Stag		Utför.	Art. nr	Vikt
Diagonalstag DS - Fzv	700/770	G	7122074	8,1
Med kilkopplingar. Rördiameter 48 mm	1250	G	7122124	9,0
DS 700/770 L=1707	1250x1500	G	7122125	7,9
DS 1250 L=2004	1655	G	7122164	10,1
DS 1655 L=2285	1655x1500	G	7122165	9,1
DS 1964 L=2523	1964	G	7122194	10,9
DS 2500 L=2967	2500	G	7121254	12,6
DS 3050 L=3450	3050	G	7121304	14,3
				
Diagonalstag för trätrall DS-UB - Fzv				
Med kilkopplingar	3050	G	7121301	15,5
Rördiameter 48 mm				
DS-UB 3050 L=3448				
				
Horizontalstag HDS -Fzv				
Med kilkopplingar Rör Ø48 mm	1250x1250	G	7141010	8,5
HDS 1250x1250 L=1768	1655x1655	G	7141005	10,5
HDS 1655x1655 L=2340	3050x1655	G	7141000	13,3
HDS 3050x1655 L=3472	3050x1250	G	7141001	13,2
HDS 3050x1250 L=3298				
				
Förankring		Utför.	Art. nr	Vikt
Väggfästestag rör - Fzv	300	G	8832031	1,36
Rördiameter 48 mm - krok diameter 16mm	450	G	8832046	2,2
Tillåten belastning 9 kN	600	G	8832061	2,6
Monteras med koppling fast 48x48	900	G	8832091	3,7
	1200	G	8832121	4,8
Justerbart SVFA	SVFA 709-1109	G	8832110	4,9
				
Väggstag VST -Fzv	1000	G	7111100	5,3
Med ledbar platta	2000	G	7111200	9,1
Rördiameter 48 mm	3000	G	7111300	13,7
Monteras med koppling	4000	G	7111400	16,7
fast 48x48	5000	G	7111500	21,9
	6000	G	7111600	24,5
				







			Utför.	Art. nr	Vikt
Trall AL Lastklass 6 (6,0 kN/m ²)		1250x495	AL	2021144	7,7
		1655x495	AL	2021204	10,0
Ståltrall - Fzv Lastklass 6 (6,0 kN/m ²)		1050x495	G	2152107	10,8
		1250x495	G	2152124	12,5
		1655x495	G	2152164	15,0
Trall plastnara					
2021141 - lastklass 5 (4,5 kN/m ²)		1400x490x56		2021141	10,0
2021201 - lastklass 4 (3,0 kN/m ²)		1950x490x56		2021201	14,2
Låsebeslag trall kort				7161002	0,6
Låsebeslag trall lång				7161009	0,6
Komposittrall					
1400 - Lastklass 5 (4,5 kN/m ²)		1400x490		2021411	8,0
1950 - Lastklass 4 (3,0 kN/m ²)		1950x490		2021409	11,5
Trallås Komposit				2021410	0,03
Krokplan B=400 mm		564	AL	4073054	4,3
Med glasfiberskiva		700	AL	4073074	4,8
Lastklass 3 (2,0 kN/m ²)		770	AL	4073078	5,1
Med lås i vardera ände		1010	AL	4073104	6,2
		1050	AL	4073108	6,2
		1250	AL	4073124	7,5
		1550	AL	4073154	8,7
		1655	AL	4073164	9,1
		1964	AL	4073194	10,3
		2050	AL	4073204	10,7
		2500	AL	4073254	12,9
		2550	AL	4073258	13,1
		3050	AL	4073304	15,2
Krokplan B=600 mm			564	AL	4071058
Med glasfiberskiva		700	AL	4071078	5,7
Lastklass 3 (2,0 kN/m ²)		770	AL	4071088	6,1
Med lås i vardera ände		1010	AL	4071108	7,4
		1050	AL	4071118	7,4
		1250	AL	4071128	9,1
		1550	AL	4071158	10,5
		1655	AL	4071168	11,1
		1964	AL	4071198	12,5
		2050	AL	4071208	12,9
		2500	AL	4071268	15,8
		2550	AL	4071278	16,1
	3050	AL	4071308	18,5	



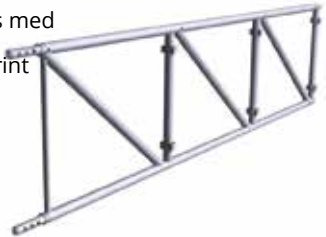

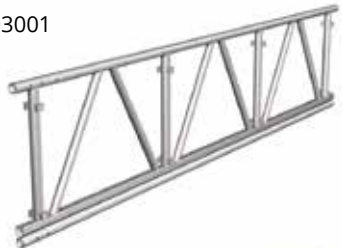
		Utför.	Art. nr	Vikt
Krokplan med lucka B=600 mm	1655	AL	4071169	13,2
Med glasfiberskiva	1964	AL	4071199	14,5
Lastklass 3 (2,0 kN/m ²)	2050	AL	4071209	15,0
Med lås i vardera ände	2500	AL	4071269	17,0
	2550	AL	4071279	17,2
	3050	AL	4071309	19,6
Steg ST - AL	2100	AL	2091210	3,4
Till krokplan med lucka				
				
Krokplan med lucka och steg				
Med glasfiberskiva	2500x600	AL	4071315	19,5
Lastklass 3 (2,0 kN/m ²)	3050x600	AL	4071310	24,5
Med lås i vardera ände				
				
AL plank B=200x90 mm	770	AL	2153079	3,6
Med vridlås i vardera ände	1050	AL	2153105	4,5
L=770-2500 - lastklass 6 (6,0 kN/m ²)	1250	AL	2153125	5,0
L=3050 - lastklass 5 (4,5 kN/m ²)	1655	AL	2153165	6,2
	1964	AL	2153195	7,1
	2500	AL	2153255	8,7
	3050	AL	2153305	10,3
AL plank B=230x90 mm	564	AL	2158056	3,5
Med vridlås i vardera ände	700	AL	2158070	3,7
L= 564-2500 - lastklass 6 (6,0 kN/m ²)	770	AL	2158077	4,1
L= 3050 - lastklass 5 (4,5 kN/m ²)	1010	AL	2158100	4,9
	1050	AL	2158105	6,9
	1250	AL	2158120	7,9
	1550	AL	2158150	6,5
	1655	AL	2158160	6,9
	1964	AL	2158190	7,8
	2050	AL	2158205	8,1
	2500	AL	2158250	9,5
	2550	AL	2158255	9,7
	3050	AL	2158300	11,2







		Utför.	Art. nr	Vikt
AL plank B=295x90 mm	770	AL	2153078	4,4
Med vridlås i vardera ände	1050	AL	2153104	5,4
L=770-1964 - lastklass 6 (6,0 kN/m ²)	1250	AL	2153124	6,1
L=2500 - lastklass 5 (4,5 kN/m ²)	1655	AL	2153164	7,5
L=3050 - lastklass 4 (3,0 N/m ²)	1964	AL	2153194	8,6
	2500	AL	2153254	10,5
	3050	AL	2153304	12,4
				
AL plank B=320x90 mm	770	AL	2153077	4,7
Med vridlås i vardera ände	1050	AL	2153103	5,7
L= 770-1964 - lastklass 6 (6,0 kN/m ²)	1250	AL	2153123	6,4
L=2500 - lastklass 5 (4,5 kN/m ²)	1655	AL	2153163	7,9
L=3050 - lastklass 4 (3,0 kN/m ²)	1964	AL	2153193	9,1
	2500	AL	2153253	11,0
	3050	AL	2153303	13,1
				
HAKI Stålp plank B=200 mm - Fzv	564	G	21510564	4,2
L= 564-2500 - lastklass 6 (6,0 kN/m ²)	700	G	21510700	4,6
L=2550-3050 - lastklass 5 (4,5 kN/m ²)	770	G	21510770	5,0
	1010	G	21511010	6,5
	1050	G	21511050	6,8
	1250	G	21511250	7,4
	1655	G	21511655	9,5
	1964	G	21511964	11,1
	2050	G	21512050	11,5
	2500	G	21512500	13,8
	2550	G	21512550	14,3
	3050	G	21513050	17,0
				
HAKI Stålp plank B=230 mm - Fzv	564	G	21520564	4,2
L= 564-2500 - lastklass 6 (6,0 kN/m ²)	700	G	21520700	5,1
L=2550-3050 - lastklass 5 (4,5 kN/m ²)	770	G	21520770	5,3
	1010	G	21521010	6,6
	1050	G	21521050	6,9
	1250	G	21521250	7,6
	1655	G	21521655	9,7
	1964	G	21521964	11,8
	2050	G	21522050	12,2
	2500	G	21522500	14,6
	2550	G	21522550	15,2
	3050	G	21523050	17,7
				



		Utför.	Art. nr	Vikt
Fotlist				
Trä, gul täcklasyr				
FL 3000x150x32 för fotlistbeslag 2131001	Fotlist FL 3000x150x32		2025300	5,8
FL 3300x150x32 för fotlistbeslag 7161006, 4161010, 7161010 eller 2131003	Fotlist hak FL 3300x150x32		2025331	5,6
Kan förses med valfri logotype				
				
Fotlist				
Aluminium				
	Teleskopisk FL 1200-1964	AL	2026020	5,0
	Teleskopisk FL 1900-3050	AL	2026021	7,3
	564	AL	4161051	1,0
	700	AL	4161071	1,3
	770	AL	4161077	1,4
	1010	AL	4161101	1,8
	1050	AL	4161105	1,9
	1250	AL	4161121	2,2
	1550	AL	4161151	2,8
	1655	AL	4161161	2,9
	1964	AL	4161191	3,5
	2050	AL	4161201	3,6
	2210	AL	4161221	4,0
	2357	AL	4161231	4,2
	2500	AL	4161251	4,6
	2550	AL	4161255	4,6
	3050	AL	4161301	5,5
				
Fotlistbeslag - Fzv				
Med kilkoppling				
		LF 70	G	7161006
		LF 70 kort	G	7161012
Fotlistbeslag AL				
LFT 70 för fotlist med hak 2025331 och trätrall		LFT 70	AL	4161010
LF 70 för fotlist H=150mm och trall AL 2021204, 2021144		LF 70	AL	4161011
Fotlistbeslag				
Plast		LFP 150x32		2131001
För hörnlösningar - Fzv			G	2131002
Fjäderstål				2131003



		Utför.	Art. nr	Vikt
Konsol utan spirskarv - Fzv Rördiameter 48 mm Med fjäderlås		SK 230	G 7211025	1,6
		SK 300	G 7211033	2,0
		SK 334	G 7211035	2,0
		SK 400	G 7211041	2,1
		SK 460	G 7211045	2,3
		SK 600	G 7211061	2,7
Konsol med spirskarv- Fzv Rördiameter 48 mm Med fjäderlås		SK 564	G 7211051	5,8
		SK 700	G 7211067	5,9
		SK 770	G 7211071	6,5
Konsol justerbar- Fzv Justerbar 460 - 690 mm Lastklass 3 (2,0 kN/m ²) OBS! Får ej monteras i HAKI Universal AL spira		SK 460-690	G 7211069	4,1
Konsoldiagonal- Fzv Kombineras med enrörsbalk 1250 eller längdbalk 1250		SKD 1250	G 7212001	11,1
Konsol- Fzv Nyckelvidd 22 mm Innerhörnkonsol Kombineras med konsol SK 460		SKH 460	G 7211046	6,7
Hörnkonsol AL		564x564	4011020	4,5
		770x770	4011021	7,3
		1250x1250	4011022	14,5

		Utför.	Art. nr	Vikt
Fackverksbalk - Fzv				
	500/6100	G	7031602	59,1
750 Fackverk Stål- Fzv				
Fackverken skarvas med	1000	G	7031100	14,4
6 st 2116000 låssprint	2000	G	7031200	26,8
	3000	G	7031300	38,8
750 Skarvdel Stål- Fzv				
Skarvdelen skarvas med		G	7203007	6,0
12 st 2116000 låssprint				
Fackverksbalk AL				
L=1250, 2250, 3250 resp. 6250 mm	1250	G	4032125	9,4
Fackverken skarvas med	2250	G	4032225	16,6
2 st skarvrör 7203001	3250	G	4032325	23,9
och 8 st låssprint	6250	G	4032625	46,0
2113100				
				
	Skarvrör 750	G	7203001	2,0
				
	Låssprint 12	G	2113100	0,1
				
750 Koppling variabel SS- Fzv				
För specialprofilen på fackverk 750 AL	vert. 48	G	2048007	1,8
Nyckelvidd 22 mm	hor. 48	G	2048008	1,8
				







		Utför.	Art. nr	Vikt
450 Fackverksbalk m. byglar - AL				
L=2220, 4100, 6100 resp. 8100 mm	Låssprint 12 Fzv	G	2113100	0,1
Med byglar på vertikaler och hål i övre röret	FB 2220	AL	4032211	9,9
för skenfästen	FB 4100	AL	4032411	17,8
Fackverken skarvas med 2 st 7203000	FB 6100	AL	4032611	25,8
Skarvrör rakt och 8 st låssprint 12 mm per skarv	FB 8100	AL	4032811	34,0
	Skarvrör rakt enkelt Fzv	G	7203000	2,0
450 Fackverksbalk AL				
L= 4100, 6100 resp. 8100 mm	FB 4100	AL	4032410	16,7
Fackverken skarvas med 2 st 7203000	FB 6100	AL	4032610	24,3
Skarvrör rakt och 8 st låssprint 12 mm per skarv	FB 8100	AL	4032810	32,3
	Skarvrör rakt enkelt Fzv	G	7203000	2,0
	Låssprint 12 Fzv	G	2113100	0,1
Adapter fackverksbalk - Fzv				
	750	G	7203337	6,9
	450	G	7203338	5,8
Adapter Ställbar Fzv				
	750	G	7203339	21,0







		Utför.	Art. nr	Vikt
UTV Trappa AL Med vilplan och låsning Bredd 600 mm 	UTV Handledare 2500x2000	AL	4058245	9,2
	UTV Handledare 3050x2000	AL	4058300	10,3
	UTV Trappa 2500x2000	AL	4102247	22,9
	UTV Trappa 3050x2000	AL	4102302	29,2
	Fäste LSS-UTV	G	7058300	1,5
UTV Trappa - Fzv Med vilplan och låsning LxH 3050x2000 mm Bredd 600 mm 	UTV Trapp 3050x2000	G	2092200	39,7
	Handledare HL 3050x2000	G	2161300	19,3
	Fäste LSS-UTV	G	8752001	2,5
Ledstångsstolpe LSS 1000 - Fzv För trappa UTV AL och UTV Fzv 		G	7015102	4,2
UTV Handledare inre - Fzv Bredd 600 mm För trappa UTV AL resp. UTV Fzv 	3050 till stål	G	7058254	11,5
	3050 till AL	G	7058253	11,4
	2500 till AL	G	7058256	10,4
	3050x1500	G	7058259	10,1
UTV Trappa AL Med vilplan och låsning Bredd 600 mm 	UTV 500	AL	4102050	5,5
	UTV 1000	AL	4102100	9,0
	UTV 1500	AL	4102150	11,3
Instegstrappa - Fzv 	700/770	G	7103065	7,8
	1250	G	7103120	11,1
	1655	G	7103160	14,7
STV Stege med vilplan - Fzv Med vilplan och låsning LxH 1250x2000 mm alt. 1655x2000 mm Bredd 475 mm 	STV 1250	G	7083202	12,5
	STV 1655	G	7083203	17,1







			Utför.	Art. nr	Vikt
SS Upphångningsbeslag Gallerdurk- Fzv			G	7171001	2,4
Tillåten belastning 20,0 kN					
SS Upphångningsbeslag H-balk- Fzv		150-300	G	7172000	6,8
Tillåten belastning 20,0 kN		300-450	G	7172001	7,6
För H-balk med flånsbredd 150-300 mm,		80-180	G	7172100	5,1
300-450 mm resp. 80-180 mm					
SS Upphångningsbeslag L-balk- Fzv			G	7176000	5,3
Tillåten belastning 20,0 kN					
För L-balk med flånsbredd 60-120 mm					
SS Upphångningsbeslag Kåttling- Fzv		1362	G	7175001	4,3
Tillåten belastning 20,0 kN		850	G	7175002	3,0
Bygghöjd 1362 resp. 850 mm		2000	G	7175004	4,8
SS Upphångningsbeslag KF 48 dubbel			G	7175101	2,1
Håldiameter 20 mm					
Nyckelvidd 22 mm					
Tillåten belastning 20,0 kN					
SS Upphångningsbeslag Bulb-Kåttling- Fzv			G	7177001	2,5
För bulbplåt 200x10-300x13mm			G	7177002	2,5
160x9-200x12 mm,			G	7177003	3,7
320x11,5-370x16 mm					
Tillåten belastning 20,0kN					
För bulbplåt 160x8 mm			G	7177000	1,6
Tillåten belastning 12,0 kN					
Kan modifieras för andra dimensioner					
SS Upphångningsbeslag Bulb-Rör- Fzv			G	7177100	3,0
För bulbplåt 160x8 mm					
Nyckelvidd 22 mm					
Tillåten belastning 20,0 kN					
Kan modifieras för andra dimensioner					
SS Klåmbeslag- Fzv			G	7215032	5,5
Nyckelvidd 30 mm		500			
Monteras på plåtkant, tjocklek 15-35 mm					





			Utför.	Art. nr	Vikt
Höjdinställningsspira- Fzv			G	7202001	6,5
Mellanspira- Fzv		S 1000 21	G	7015009	6,1
För montage i innerhörn mellan		S 1000 22	G	7015010	6,1
två längdbalkar		S 1500 21	G	7015011	8,8
Nyckelvidd 21 mm resp. 22 mm		S 1500 22	G	7015012	8,8
		S 2000 21	G	7015007	12,5
		S 2000 22	G	7015008	12,5
Tvärbalk ITL- Fzv		564	G	7204050	3,6
		700	G	7204070	4,1
		770	G	7204071	4,3
		1010	G	7204099	5,3
		1050	G	7204101	5,5
		1250	G	7204122	6,3
		1655	G	7204162	7,8
Enkelbalk- Fzv		300	G	7022030	1,5
Rördiameter 48 mm					
Enkelbalk- Fzv		1655	G	8722160	6,0
Med fjäderlås		2500	G	8722250	8,8
Rördiameter 42,4 mm		3050	G	8722300	10,5
Spirhållare- Fzv		50	G	7208025	2,3
För rördiameter 50 mm					
Kan låsas med låssprint 12 mm					
Spirhållare- Fzv		34	G	7208018	3,9
För rördiameter 34 mm					
Med låsskruv					





			Utför.	Art. nr	Vikt
Balkryttare- Fzv För rördiameter 50 mm Kan låsas med låssprint 12 mm		50	G	7208024	1,2
Balkryttare BRS- Fzv För rördiameter 34 mm Med låsskruv		BRS-L	G	7208020	2,0
		BRH-L	G	7208021	2,4
		BRL-L	G	7208022	2,5
Balkryttare dubbel- Fzv För skyddsräcksram eller längdbalkar Med låsskruv Nyckelvidd 22 mm resp. 21 mm		21	G	7208033	2,4
		22	G	7208031	2,4
Bygelgrupp lös- Fzv Nyckelvidd 22 mm För skyddsräck vid t ex hörnlösninga			G	8792000	0,6
Bygelkoppling 48			G	2048017	1,4
Låsklammer skyddsräck- Fzv Nyckelvidd 22 mm För skyddsräck, rördiameter 38 mm			G	8833000	0,8
Räckestolpe SRS- Fzv För montage på längdbalk		SRS 1000	G	7015001	7,3
Räckestolpe SS- Fzv För montage på längdbalk		SS 1000	G	7015000	6,1

			Utför.	Art. nr	Vikt
Räckestolpe- Fzv Nyckelvidd 23 mm alt. 22 mm För montage på enrörsbalk		23	G	7015005	6,1
		22	G	7015006	6,1
Skyddsåge- Fzv För montage på längdbalk			G	7053110	5,5
Täckplåt AL AL-durkplåt Med handtag och hål för surring För täckning av hål i inplankning		995x495x4	AL	4011000	5,2
		1010	AL	7900113	6,5
		1250	AL	7900114	6,5
Beslag skjutbar grind- Fzv För skyddsräcksram			G	7053001	9,4
Skyddstakskonsol- Fzv			G	7214066	9,5
Kombinationsbeslag- Fzv			G	7205010	2,2

			Utför.	Art. nr	Vikt
Plankryttare- Fzv		460-2 bd	G	7218023	4,0
Plankryttare- Fzv		230-1 bd	G	7218032	3,0
		460-2 bd	G	7218033	3,5
Stödben fotlist- Fzv			G	7161715	2,3
Länkhjul Wicke- Fzv Ø 38 mm Hjuldiameter 250 mm Justerbar 330-630 mm Tillåten belastning 10,0 kN, rullande 4,0 kN		LRG S4	G	2012005	7,4
Stödben AL Justerbar		STB 1000	AL	4143101	8,6
Toppklykor- Fzv BV 10 till omvänd bottenkruv och toppspira BVV 175 till spira S		BV 10	G	7155000	3,0
		BVV 175	G	7155131	3,5
Tripod- Fzv Med byglar på en spira Rördiameter 48 mm		500	G	7203340	10,0
		1000	G	7203341	17,3
		1500	G	7203344	23,3
		2000	G	7203342	31,8
		3000	G	7203343	45,8

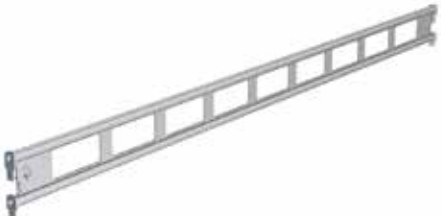

		Utför.	Art. nr	Vikt
Bottenskruv 60- Fzv		G	2071061	15,6
Adaptor Tripod- Fzv		60	G 7203312	11,6
		48	G 7203311	10,0
Topplatta Tripod- Fzv		Toppklyka BVV Tripod	G 7155100	3,0
		Topplatta Tripod	G 7203309	6,3
Ställningsbock- Fzv		SBT	G 7013010	9,2
<p>Inkl. teleskopiskt förlängningsrör. Två ställningsbockar kombineras med en balk till en bock</p> 				
Hakitainer- Fzv			G 7181110	33,6
OBS! Ej godkänd som lyftredskap.			G 7181150	39,4
Gods skall stroppas till Hakitainern vid lyft				
HAKI Galge			5211000	3,6
HAKI Galgen kombineras med linhjul eller HAKI Säkerhetsblock.			G 7164001	0,9
Kan även användas för vinsch.			G 7173002	7,9
Koppling med bygel används vid montering på t ex ställningsrör 48 mm, nyckelvidd 22 mm				
Tillåten last HAKI Galge 200 kg, Linhjul 70 kg				
HAKI Säkerhetsblock			2600290	10,0
Tillåten last 50 kg			26150AF	4,5
			Rep Ø 18 mm L= 30m	
			Säkerhetsblock, HAKI	

	Utför.	Art. nr	Vikt
Ställningsskytt Att hakas på spira Med ficka i A4 för "Fakta om ställningen"		2112000	1,1
			
Monteringsverktyg AL Monteringsverktyg skyddsräck	AL	4052001	1,4
			
Monteringsverktyg fjäderlås		1051001	0,6
			
Ställningsnyckel Med spärr	21/22 mm 22/23 mm	2051022 2051023	0,5 0,5
			

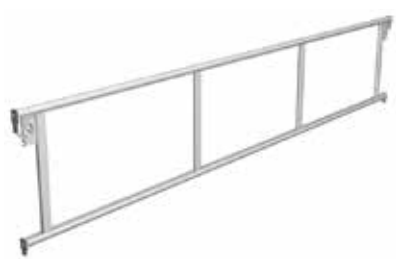
			Utför.	Art. nr	Vikt
Spira S4 AL Spirskarv med tapp Ø 38 mm Rördiameter 48 mm		S4 500	AL	4017056	1,6
		S4 1000	AL	4017106	2,8
		S4 1500	AL	4017156	4,0
		S4 2000	AL	4017206	5,2
		S4 3000	AL	4017306	7,7
Toppspira S4 SC AL		SC 353	AL	4011105	1,0
		SC 853	AL	4011104	2,2
		SC 1353	AL	4011106	3,4
		SC 1853	AL	4011107	4,6
Sprint till spirskarv AL Diameter 16 mm För förstärkning av spirskarv vid draglast t ex vid hängande ställning, lyft eller ställning för väderskyddstak		Låssprint fjäder 16	G	2116000	0,17
		Sprint med länk	G	5141257	0,3
Horisontaler			Utför.	Art. nr	Vikt
Längdbalk AL Med fjäderlås Rördiameter 34 mm		350	AL	4021031	1,9
		700	AL	4021066	2,9
		770	AL	4021073	2,9
		1050	AL	4021101	3,5
		1250	AL	4021121	4,2
		1550	AL	4021151	4,2
		1655	AL	4021161	4,8
		1964	AL	4021191	5,8
		2050	AL	4021201	5,4
		2500	AL	4021246	7,2
		2550	AL	4021247	9,8
		3050	AL	4021301	8,5
		Enrörsbalk AL Med fjäderlås Rördiameter 48 mm		564	AL
700	AL			4022066	2,7
770	AL			4022073	2,9
1010	AL			4022099	3,1
1050	AL			4022101	3,2
1250	AL			4022121	3,6
1550	AL			4022155	3,3
1655	AL			4022161	4,1
1964	AL			4022191	4,5
2050	AL			4022201	4,2
2500	AL			4022246	7,8
2550	AL			4022255	5,5
3050	AL	4022301	6,2		



		Utför.	Art. nr	Vikt
Skyddsräcksram AL	564	AL	4052051	2,7
Med fjäderlås	700	AL	4052066	3,3
	770	AL	4052073	3,5
	1010	AL	4052099	4,3
	1050	AL	4052101	4,5
	1250	AL	4052121	4,8
	1550	AL	4052155	5,0
	1655	AL	4052161	5,9
	1964	AL	4052191	6,6
	2050	AL	4052201	6,9
	2500	AL	4052246	5,4
	2550	AL	4052255	8,0
	3050	AL	4052301	8,9

Stag

		Utför.	Art. nr	Vikt
Diagonalstag AL	700/770	AL	4122070	4,0
Rördiameter 48 mm	1250	AL	4122120	4,5
	1655	AL	4122160	4,9
	1964	AL	4122190	5,4
	2500	AL	4122245	6,1
	3050	AL	4122300	6,7
	Horisontalstag HDS AL	3050x1655	AL	4141000
Rördiameter 48 mm	3050x1250	AL	4141001	6,5
HDS 3050x1655 AL L=3468	2500x1655	AL	4141006	6,3
HDS 3050x1250 AL L=3294				
HDS 2500x1655 AL L=2996				
Horisontalstag teleskopiskt HDS AL				
Rördiameter 38-48 mm				
L=1960-3470 mm		AL	4141010	6,3
För fackstorlekar från 1655x1050 mm till 3050x1655 mm med 16 fasta positioner				
				

Konsoler

		Utför.	Art. nr	Vikt
Konsol AL	SK 230	AL	4211024	1,7
Utan spirskarv	SK 320	AL	4211033	1,8
Med fjäderlås	SK 460	AL	4211047	1,9
				



		Utför.	Art. nr	Vikt
Konsol med spirskarv S4 AL Med spirskarvtapp Ø38 mm Rör diameter Ø48 mm Med fjäderlås		SK 564	AL 4211052	3,6
		SK 770	AL 4211074	3,9
Konsoldiagonal S4 AL Med spirskarvtapp Ø 38 mm Rördiameter 48 mm Med fjäderlås Kombineras med enrörsbalk 1250 eller längdbalk 1250		SKD S4-1250	AL 4212002	7,8

Övriga komponenter



		Utför.	Art. nr	Vikt
Spirhållare S4 AL		AL	4208002	1,7
Balkryttare AL		AL	4208020	1,1



		Utför.	Art. nr	Vikt	
Bottenskruv S6- Fzv		BS S6-760/515	G	2071032	6,2
Stål					
Ø 34 mm					
Justerbar 55-570 mm					

Spiror







			Utför.	Art. nr	Vikt
Spira S6 AL med split		S6 500	AL	4018050	2,2
Spirskarv med tapp Ø 34 mm		S6 1000	AL	4018100	3,7
Rördiameter Ø 48 mm		S6 1500	AL	4018150	5,3
Med monterad sprint		S6 2000	AL	4018200	6,8
		S6 3000	AL	4018300	9,9
S6 AL		S6 500	AL	4018056	2,0
Spirskarv med tapp Ø 34 mm		S6 1000	AL	4018106	3,5
Rördiameter Ø 48 mm		S6 1500	AL	4018156	5,1
Utan sprint		S6 2000	AL	4018206	6,6
		S6 3000	AL	4018306	9,7
Spira S6 SC AL		SC 353	AL	4018053	1,2
Toppspira Ø 48		SC 853	AL	4018103	2,8
		SC 1353	AL	4018153	4,3
		SC 1853	AL	4018253	5,8





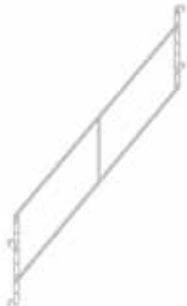

Konsoler







			Utför.	Art. nr	Vikt	
Konsol med spirskarv S6 AL		Med spirskarvstapp Ø 34 mm	SK S6-564	AL	4211053	3,9
Rördiameter 48 mm		SK S6-770	AL	4211075	4,2	
Med fjäderlås						
Konsoldiagonal S6 AL		Med spirskarvstapp Ø 34 mm	SKD S6-1250	AL	4212001	7,6
Rördiameter 48 mm						
Med fjäderlås						
Kombineras med enrörsbalk 1250 eller längdbalk 1250						







			Utför.	Art. nr	Vikt
<p>Spirhållare S6 AL</p> <p>Med spirskarvstapp Ø 34 mm</p> <p>För rördiameter 34 mm</p> <p>Med spirskarvstapp Ø 34 mm</p> <p>För rördiameter 34 mm</p>		S6	AL	4208001	1,8
<p>Länkhjul Wicke S6- Fzv</p> <p>Ø 34 mm</p> <p>Hjuldiameter 250 mm</p> <p>Justerbar 330-630 mm</p> <p>Tillåten belastning 10,0 kN, rullande 4,0 kN</p>		LRG S6		2012006	7,1





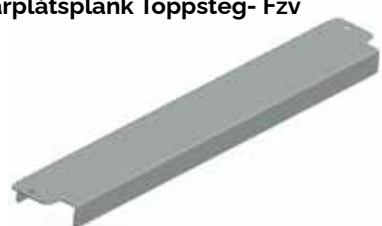

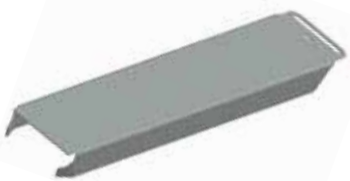
Trapporn 3050x1655 Symmetriskt







			Utför.	Art. nr	Vikt
STS Vilplan- Fzv			G	7095001	19,2
STS Trapplöp- Fzv		1000	G	7101120	32,5
		1500	G	7101151	28,6
		2000	G	7101201	33,9
STS Ledstångsstolpe- Fzv Stolpen låses med låskrok LK 8793000			G	7015102	4,2
STS Ledstångsstolpe kil- Fzv			G	7015104	4,6
STS Handledare- Fzv		1000	G	7058104	9,4
		1500	G	7058153	7,5
		2000	G	7058203	8,4
STS Skyddsgrind- Fzv		SGTS	G	7053002	10,9

			Utför.	Art. nr	Vikt
STS Fotlist AL					
Fotlist övre		780	G	7900029	1,75
Fotlist		1655	AL	4161161	2,9
Fotlist		3050	AL	4161301	5,5
STS Skyddsgrind- Fzv		SGS	G	7053003	7,6
STS Skyddsräcksram- Fzv		GFL 2210	G	7052222	8,6
		GFL 2357	G	7052232	8,6
					
STS Instegstrappa- Fzv		1655	G	7103160	14,7
STS Låskrok- Fzv		LK 10x48	G	8793000	0,1

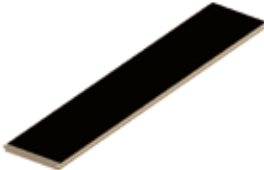

			Utför.	Art. nr	Vikt
PAS Vangstycke- Fzv		1655x1000	G	7102100	25,0
		2500x1500	G	7102150	34,5
PAS Handledare- Fzv		1655x1000	G	7058100	26,5
		2500x1500	G	7058152	36,5
PAS Handledare- Fzv		1655x500	G	7058050	24,0
PAS Skyddsräcke- Fzv		300	G	7053030	7,5
		564	G	7053056	12,1
		700	G	7053070	11,9
		770	G	7053077	12,5
		1100/770 Tripod	G	7053078	11,0
		1100/770 Utbyggd	G	7053079	18,5
		1050	G	7053105	15,7
		1250	G	7053125	19,5
		1655	G	7053165	23,0
		1964	G	7053191	28,2
PAS/HBS Enrörsbalk m täckplåt- Fzv		1250	G	7104125	6,7
		1250 S	G	7104126	7,2
		1655	G	7104165	8,5
		1655 S	G	7104166	9,2
		1964	G	7104191	10,0
		1964 S	G	7104192	10,7
		2500 S	G	7104257	13,7
PAS Handledare insteg- Fzv		3-steg	G	7058004	15,0
PAS Vangstycke insteg- Fzv		3-steg	G	7102006	10,7

		Utför.	Art. nr	Vikt
PAS Bottenstag Vangstycke- Fzv 	1655	G	7125166	8,1
	2500	G	7125251	11,5
PAS Tårplåtsplank Insteg- Fzv 	1250x270	G	2140121	14,5
	1655x270	G	2140161	20,4
	1964x270	G	2140191	24,2
PAS/HBS Tårplåtsplank Toppsteg- Fzv 	1250x250	G	2140122	14,9
	1655x250	G	2140162	17,3
	1964x250	G	2140192	19,7
	2500x250	G	2140252	25,0
PAS Tårplåtsplank- Fzv 	1250x300	G	2140123	15,0
	1655x300	G	2140163	23,4
	1964x300	G	2140193	27,0
PAS Handledare Tripod- Fzv 		G	7058000	7,1
PAS/HBS Tårplåtsplank- Fzv 	1250x200	G	2140125	13,1
	1655x200	G	2140165	17,4
	1964x200		2140195	20,6
PAS/HBS Tårplåtsplank- Fzv 	1250x250	G	2140126	14,9
	1655x250	G	2140166	19,7
	1964x250	G	2140196	23,4

		Utför.	Art. nr	Vikt
HBS Enrörsbalk med skruvlås SBF- Fzv 	1250	G	7104124	5,3
	1655	G	7104164	6,6
	1964	G	7104194	7,5
	2500	G	7104254	9,1
HBS Tårplåtspank- Fzv 	1250x200	G	2140125	13,1
	1250x250	G	2140126	14,9
	2500x200	G	2140255	26,2
	2500x250	G	2140256	29,8
HBS Horisontalstag- Fzv 	1250x1250	G	7105121	4,4
	2500x1250	G	7105126	8,1
	1250x1655	G	7105161	5,0
	1250x1964	G	7105191	5,7
	2500x1655	G	7105195	7,4
	2500x1964	G	7105197	7,7
	2500x2500	G	7105199	8,7
	1250x2500	G	7105251	6,8
HBS Pelare- Fzv 	Nederdel	G	7104108	23,6
	Ovandel	G	7104109	21,5
	Mellandel	G	7104140	16,0
HBS Diagonalstag- Fzv 	1250	G	7104138	14,8
	2500	G	7104119	17,0
HBS Övre Balk- Fzv 	1250	G	7104135	10,9
	2500	G	7104118	23,2
HBS Nedre Balk- Fzv 	1250	G	7104136	12,5
	2500	G	7104130	26,8

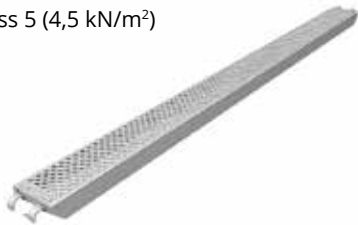
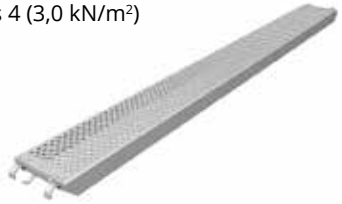
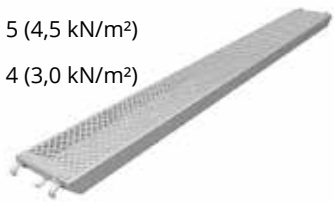





		Utför.	Art. nr	Vikt		
HBS Inklädnadspanel			250x1250	2033120	2,0	
			250x2500	2033250	4,0	
			500x1250	2033122	4,0	
			500x2500	2033252	8,0	
HBS U-Profil inklädnadspanel- Fzv			Vänster	G	7104129	3,5
			Höger	G	7104131	3,5
HBS H-Profil inklädnadspanel- Fzv				G	7104132	7,0
HBS Läsklämma inklädnadspanel				G	7104133	0,5
HBS Tripod Toppadapter inkl. klämbeslag - Fzv				G	7104111	27,5
HBS Sprint			20 L=125		2113010	0,3
			16 L=90		2113011	0,2
			20 L=70		2113012	0,2
			R-Sprint A-E4	G	6130203	0,02
			Bricka SRB 21x36x3	G	6130296	0,02



		Utför.	Art. nr	Vikt
AL plank B=200 mm				
Med vridlås i vardera ände	770x200x90	AL	2153079	3,6
L=770-2500 - lastklass 6 (6,0 kN/m ²)	1050x200x90	AL	2153105	4,5
L=3050 - lastklass 5 (4,5 kN/m ²)	1250x200x90	AL	2153125	5,0
	1655x200x90	AL	2153165	6,2
	1964x200x90	AL	2153195	7,1
	2500x200x90	AL	2153255	8,7
	3050x200x90	AL	2153305	10,3
	AL plank B=295 mm			
Med vridlås i vardera ände	770x295x90	AL	2153078	4,4
L=770-1964 - lastklass 6 (6,0 kN/m ²)	1050x295x90	AL	2153104	5,4
L=2500 - lastklass 5 (4,5 kN/m ²)	1250x295x90	AL	2153124	6,1
L=3050 - lastklass 4 (3,0 kN/m ²)	1550x295x90	AL	2153156	7,2
	1655x295x90	AL	2153164	7,5
	1964x295x90	AL	2153194	8,6
	2050x295x90	AL	2153206	9,0
	2500x295x90	AL	2153254	10,5
	2550x295x90	AL	2153256	10,5
	3050x295x90	AL	2153304	12,4
AL plank B=320 mm				
Med vridlås i vardera ände	770x320x90	AL	2153077	4,7
L= 770-1964 - Lastklass 6 (6,0 kN/m ²)	1050x320x90	AL	2153103	5,7
L=2500 - Lastklass 5 (4,5 kN/m ²)	1250x320x90	AL	2153123	6,4
L=3050 - Lastklass 4 (3,0 kN/m ²)	1655x320x90	AL	2153163	7,9
	1964x320x90	AL	2153193	9,1
	2500x320x90	AL	2153253	11,0
	3050x320x90	AL	2153303	13,1

		Utför.	Art. nr	Vikt	
Motvikt		Motvikt betong 1500 kg	2121000	1500	
		Bricka SRB 21x36x3	G	6130296	0,02
		Skruv M20x140	G	6130350	0,4
		Fyrkantrör 50x50-650		7156000	4,2
Bottenskruv- Fzv Ledat bottenrör L=1200 mm Ø 60 mm Justerbar 176-711 mm Nyckelvidd 22 mm		BSLL 1200	G	7153007	19,4
Bygelgrupp- Fzv 4x60°		4x60	G	7206000	2,6
Koppling fast- Fzv Vinkel 30° Nyckelvidd 22 mm		KF 34x48 30	G	7164000	1,1
Skyltklammer- Fzv För kantbockad plåtskylt			G	2111000	0,4
Belysningskonsol- Fzv Nyckelvidd 22 mm			G	7213000	1,8

		Utför.	Art. nr	Vikt
Bottenskruv- Fzv Justerbar 55-570 mm		G	2071000	5,0

Ramar

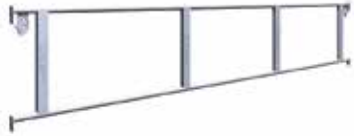
			Utför.	Art. nr	Vikt
Ram 2000- Fzv		RA 2000	G	8731204	17,1
Ram 1000- Fzv		RA 1000	G	8731104	12,4
Ram 800- Fzv		RA 800	G	8731084	10,0
Ram 500- Fzv		RA 500	G	8731053	7,0
Ram med fotlist- Fzv		RAF 1000	G	8731105	14,5
L-ram- Fzv		RAL 1000	G	8734100	6,1
		RAL 2000	G	8734200	9,8

		Utför.	Art. nr	Vikt
Skyddsräcksram GFL - Fzv				
Med fjäderlås	700	G	7052070	3,8
Rör oktagon 28 mm	1250	G	7052124	5,7
	1655	G	7052164	7,4
	1964	G	7052194	8,1
	2500	G	7052254	9,2
	3050	G	7052304	10,5
Skyddsräcksram- Fzv	SKRDF 700	G	8753000	7,5
Med fotlist				
	SKRA 500-700	G	8751075	4,4
Skyddsräcksram SKRA- Fzv				
				

Förankring

		Utför.	Art. nr	Vikt
Väggfästestag rör - Fzv				
Rördiameter 48 mm, krok diameter 16 mm	SVF 300x48	G	8832031	1,4
Tillåten belastning 9 kN	SVF 450x48	G	8832046	2,2
Monteras med koppling fast 48x48	SVF 600x48	G	8832061	2,6
	SVF 900x48	G	8832091	3,7
Justerbart	SVFA 709-1109	G	8832110	4,9
	SVF 1200x48	G	8832121	4,8

Inplankning



		Utför.	Art. nr	VIKT
Plan B=620 mm AL				
Med glasfiberskiva	PL 700x620	AL	4081077	6,0
Lastklass 3 (2,0 kN/m ²)	PL 1250x620	AL	4081127	9,5
	PL 1655x620	AL	4081167	11,6
	PL 1964x620	AL	4081197	13,1
	PL 2500x620	AL	4081257	16,6
	PL 3050x620	AL	4081307	18,9
Plan B=310 mm AL				
Med glasfiberskiva	PL 1655x310	AL	4082167	7,7
Lastklass 3 (2,0 kN/m ²)	PL 1964x310	AL	4082197	8,9
	PL 2500x310	AL	4082247	11,3
	PL 3050x310	AL	4082307	13,4
Ramplan med lucka AL				
Med glasfiberskiva	PLLU 1964x620	AL	4081192	14,8
Lastklass 3 (2,0 kN/m ²)	PLLU 2500x620	AL	4081242	17,4
	PLLU 3050x620	AL	4081303	20,2

			Utför.	Art. nr	Vikt
Stege ST AL		2100	AL	2091210	3,4
Till Plan med lucka PLLU					

Fotlister

			Utför.	Art. nr	Vikt
Fotlist		FL 3000x150x32		2025300	5,8
Trä, gul täcklasyr		FL 3300x150x32		2025331	5,6
Kan förses med valfri logotype					



Fotlistbeslag

Plast		LFP 150x32		2131001	0,2
Stål		LF 70 Kort	G	7161012	0,7

Konsoler





			Utför.	Art. nr	Vikt
Konsol- Fzv		SK 300	G	8775030	3,9
		SK 700	G	8775070	7,9
		SK 800	G	8775080	9,1

Trappor



			Utför.	Art. nr	Vikt
UTV Trappa AL		Låssprint 12 mm	G	2113100	0,1
Med vilplan och		Handledare HL 2500x2000	AL	4058245	9,2
låsning		Handledare HL 3050x2000	AL	4058300	10,3
LxH 3050x2000 mm		Trappa UTV 1000	AL	4102100	9,0
alt. 2500x2000 mm		Trappa UTV 2500x2000	AL	4102247	22,9
Bredd 600 mm		Trappa UTV 3050x2000	AL	4102302	29,2
		Ledstångsstolpe LSS 1000	G	7015102	4,2
		Fäste LSS-UTV AL	G	7058300	1,5
UTV Trappa - Fzv		Trappa UTV 3050x2000	G	2092200	39,7
Med vilplan och		Låssprint 12 mm	G	2113100	0,1
låsning		Handledare HL 3050x2000	G	2161300	19,3
LxH 3050x2000		Ledstångsstolpe LSS 1000	G	7015102	4,2
Bredd 600 mm		Fäste LSS-UTV	G	8752001	2,5

	Utför.	Art. nr	Vikt
Täckplåt UTV AL/Ramplan För täckning av hålet mellan vilplan och ramplan Endast för UTV AL 		7211044	3,6

Övriga komponenter

	Utför.	Art. nr	Vikt
Upplagsbalk- Fzv 	G	8743700	2,4
Låsbalk- Fzv 	G	8744700	2,3
	G	8744701	2,3
Tvärprofil- Fzv Nyckelvidd 22 mm 	G	8743701	3,7
Bygelgrupp lös- Fzv 	G	2048017	1,4
Låsklammer skyddsräck- Fzv För skyddsräck, rördiameter 38 mm Nyckelvidd 22 mm 	G	8833000	0,8
Låskrok- Fzv För låsning av spirskarv vid draglast t ex vid lyft. Ej för hängande ställning 	G	8793000	0,1
Markram- Fzv Med 2 fasta och 2 skjutbara spirtappar Fackbredd 1460 mm 	G	8732201	39,5
Ramtainer- Fzv För 20 st stående rammar Ramarna surras till ramtainern med spännband 	G	8871000	28,9

Ramar

			Utför.	Art. nr	Vikt
Ram 2000 AL		RA 2000	AL	4731201	8,9
Ram 1000 AL		RA 1000	AL	4731101	6,4
Ram 800 AL		RA 800	AL	4731081	5,1
Ram 500 AL		RA 500	AL	4731051	3,8
Ram med fotlist		RAF 1000	AL	4731105	7,7

Skyddsräcken







			Utför.	Art. nr	Vikt
Skyddsräcksram AL		SKRD 700	AL	4052066	3,3
Med fjäderlås		SKRD 1250	AL	4052121	4,8
		SKRD 1655	AL	4052161	5,9
		SKRD 1964	AL	4052191	6,6
		SKRD 2500	AL	4052246	7,8
		SKRD 3050	AL	4052301	8,9

			Utför.	Art. nr	Vikt
Konsol AL		SK 700 22 mm	AL	4211072	3,5
Konsol SK 700 med och konsol SK 650 utan spirskarv Nyckelvidd 22 mm		SK 650 22 mm	AL	4211073	3,0

		Utför.	Art. nr	Vikt
Ställningsrör- Fzv 	SR 48-1000	G	7241100	4,1
	SR 48-1500	G	7241150	6,1
	SR 48-2000	G	7241200	8,0
	SR 48-2500	G	7241250	10,3
	SR 48-3000	G	7241300	12,4
	SR 48-3500	G	7241350	14,1
	SR 48-4000	G	7241400	16,7
	SR 48-4500	G	7241450	18,0
	SR 48-5000	G	7241500	20,1
	SR 48-6000	G	7241600	24,1







Rörkopplingar

		Utför.	Art. nr	Vikt
Koppling fast- Fzv Nyckelvidd 22 och 23 mm 	RA 48x48 22	G	2048010	1,2
	RA 48x48 23	G	2048012	1,2
Koppling variabel- Fzv Nyckelvidd 22 och 23 mm 	SW 48x48 22	G	2048011	1,4
	SW 48x48 23	G	2048013	1,4
Övriga kopplingar- Fzv 	Balkkoppling SK 48 1-19		2044000	1,3
	Skarvkoppling 48		2045001	1,3
Ställningsnyckel Med spärr 	21/22 mm		2051022	0,5
	22/23 mm		2051023	0,5
Hylsnyckel Nyckelvidd 23 mm 	23 mm	G	2051000	0,6
Adapter För koppling 48 mm på 34 mm rör 	35		2041001	0,03

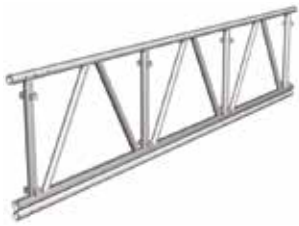





		Utför.	Art. nr	Vikt
450 Fackverksbalk m. byglar AL	2220	AL	4032211	9,9
Med byglar på vertikaler och hål i övre röret för skenfästen	4100	AL	4032411	17,8
Fackverken skarvas med 2 st 7203000 Skarvrör rakt och	6100	AL	4032611	25,8
8 st låssprint 12 mm per skarv	8100	AL	4032811	34,0
				
450 Fackverksbalk AL	4100	AL	4032410	16,7
Fackverken skarvas med 2 st 7203000 Skarvrör rakt och	6100	AL	4032610	24,3
8 st låssprint 12 mm per skarv	8100	AL	4032810	32,2
				
450 Skarvrör - Fzv				
Skarvrören skall monteras med 4 st	Skarvrör 22,5 undre	G	7201316	2,6
låssprint 12 mm per skarvrör	Skarvrör rakt enkelt	G	7203000	2,0
	Skarvrör 30 undre	G	7203003	2,8
	Skarvrör 30 övre	G	7203004	5,7
	Skarvrör 15 undre	G	7203005	2,3
	Skarvrör 15 övre	G	7203008	4,0
	Skarvrör 22,5 övre	G	7203013	4,2
				
450 Skarvrör takfot- Fzv				
Skarvrören skall monteras med	Skarvrör takfot 15 inre	G	7201313	2,6
låssprint 12 mm	Skarvrör takfot 22,5 inre	G	7201315	2,9
	Skarvrör takfot 15 yttre	G	7203012	5,1
	Skarvrör takfot 22,5 yttre	G	7203014	3,9
				
Enkelbalk- Fzv	2500	G	8722250	8,8
Med fjäderlås	3050	G	8722300	10,5
Rördiameter 42 mm				
450 Takfotsbeslag- Fzv		G	7014000	3,8
				







	Utför.	Art. nr	Vikt
450 Väggestolpe- Fzv För fackverkbalk 450 AL Monteras med 4 st låssprint 12 mm	G	7014010	12,7

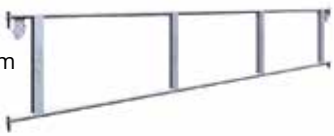



















		Utför.	Art. nr	Vikt
750 Fackverk AL 	1250	AL	4032125	9,4
	2250	AL	4032225	16,6
	3250	AL	4032325	23,9
	6250	AL	4032625	46,0
750 Fackverksvinkel AL 	15°	AL	4202260	18,3
	22,5°	AL	4202261	17,6
	37,5°	AL	4202267	16,6
750 Skarvrör- Fzv 		G	7203001	2,0
Låssprint- Fzv Diameter 12 mm resp. 16 mm 	Låssprint Ø12	G	2113100	0,1
	Låssprint fjäder Ø 16	G	2116000	0,2
Bult 	HCB-bult 12x80	G	6130049	0,08
	R-Sprint	G	6130441	0,01
750 Diagonalstag AL Rördiameter 53 mm OBS! Normal rörkoppling 48 mm kan ej kopplas till röret 	1250x1000	AL	4122119	1,0
	1250x1250	AL	4122121	2,7
	1250x2000	AL	4122123	4,0
	1250x2250	AL	4122124	4,0
	1655x1000	AL	4122159	3,0
	1655x1250	AL	4122162	3,4
	1655x2000	AL	4122163	3,3
	1655x2250	AL	4122164	4,0
	1964x1000	AL	4122191	3,5
	1964x1250	AL	4122192	3,7
	1964x2000	AL	4122193	4,3
	1964x2250	AL	4122194	4,6
	2500x1000	AL	4122248	1,6
	2500x1250	AL	4122249	4,4
	2500x2250	AL	4122253	5,1
	2500x2000	AL	4122254	4,9
3050x1000	AL	4122298	1,8	
3050x1250	AL	4122299	5,0	
3050x2000	AL	4122303	5,5	
3050x2250	AL	4122304	5,6	



			Utför.	Art. nr	Vikt
750 Räckestolpe- Fzv			G	7203322	10,5
750 Koppling variabel SW		vert. 48	G	2048007	1,8
Nyckelvidd 22 mm		hor. 48	G	2048008	1,8
För specialprofilen på fackverk 750 AL					
750 Fackverksupplag- Fzv			G	7203335	16,8
Inkl. 2 st klämbeslag					
Ställbar i 12-22° samt 0°					
750 Fackverksupplag kompakt			G	7203336	22,5
Inkl. 2 st klämbeslag					
Ställbar i 12-22° samt 0°					
750 Bottenram- Fzv			G	7203320	10,4
750 Fasthjul med spår- Fzv			G	7142003	9,9
750 Krok lyftsäkring- Fzv			G	7175059	3,1
Inkl. 2 st M12x40 skruv och låsmutter					
U-profil lyftsäkring- Fzv		3000	G	7175060	16,0
Inkl. 7 st resp. 5 st M14x30 skruv och låsmutter		2000	G	7175061	10,6

			Utför.	Art. nr	Vikt
750 Triangelbalk- Fzv Rördiameter 48 mm		2000	G	7203332	31,7
		3000	G	7203333	44,0
750 Rälskoppling- Fzv		Överdel	G	2044100	1,3
		Underdel	G	2044101	0,6
Spännband		10 m 4000 kg		2051601	2,5
750 Dragok- Fzv För dukmontering		1250	G	7500011	7,8
		1655	G	7500025	9,4
		1964	G	7500017	10,6
		2500	G	7500009	12,6
		3050	G	7500008	14,8
750 Duksträckare- Fzv		1250	G	7500013	5,9
		1655	G	7500027	7,6
		1964	G	7500040	7,0
		2500	G	7500014	10,6
		3050	G	7500015	12,9
750 Duksträckarrör- Fzv		1250	G	7500024	4,3
		1655	G	7500028	5,9
		1964	G	7500042	5,6
		2500	G	7500023	9,2
		3050	G	7500022	11,3
750 Nockrulle med ram- Fzv		1250	G	7500018	11,2
		1655	G	7500019	13,9
		1964	G	7500041	16,0
		2500	G	7500020	17,9
		3050	G	7500021	20,5
Skyddsräcksram GFL- Fzv Med fjäderlås Rör oktagon 28 mm		1250	G	7052124	5,7
		1655	G	7052164	7,4
		1964	G	7052194	8,1
		2500	G	7052254	9,2
		3050	G	7052304	10,5

		Utför.	Art. nr	Vikt
750 Skena nock AL Taklutning 15°, 22,5° alt. 37,5° Utan monterad 7540001 skarvpinne AL Märkt med art. nr i ena änden		15°	G 7541015	2,8
		22,5°	G 7541022	2,8
		37,5°	G 7541037	3,0
750 Skena AL L=1250, 2250, 3250 och 6250 mm Med 7540001 skarvpinne AL monterad i övre änden Märkt med art. nr i övre änden		1250	G 7541125	2,6
		2250	G 7541225	4,7
		3250	G 7541325	6,7
		6250	G 7541625	12,9
750 Skena takfot AL Taklutning 15°, 22,5° alt. 37,5° Med 7540001 skarvpinne AL monterad i övre änden Märkt med art. nr i övre änden		15°	G 7541150	3,3
		22,5°	G 7541220	3,3
		37,5°	G 7541370	3,3
750 Fallskyddsfäste Trak- Fzv			G 7541006	7,6
750 Fallskyddsfäste- Fzv För HAKITEC 750 med HAKI Trak Med skena nock taklutning 15° alt. 22,5°		15°	G 7541007	10,4
		22,5°	G 7541008	10,4
750 Rullkonsol- Fzv För dukmontering			G 7500010	7,4

		Utför.	Art. nr	Vikt
750 Skarvdon- Fzv		G	7540000	0,2
750 Skarvpinne AL		AL	7540001	0,04
750 Skarvpackning			7540002	0,1
750 Spännband			7540003	0,5
			3 m 450 kg	
750 Skenfäste- Fzv		G	7541000	0,5
Monteras till fackverk 750 AL med 1 st 2113100 låssprint 12 mm OBS! 2113000 låssprint fjäder 12 mm rekommenderas ej för denna applikation				
750 Skenfäste takfot- Fzv		G	7541002	1,3
Monteras till fackverk 750 AL med 1 st 2113100 låssprint 12 mm OBS! 2113000 låssprint fjäder 12 mm rekommenderas ej för denna applikation				
Ringnyckel			2051019	0,3
Med spärr			2051021	0,3
			19	
			22	
Skenfäste koppling- Fzv		G	2048030	1,0
Nyckelvidd 22 mm				
Styrning Trak duk- Fzv		G	7541005	1,1
För dukmontering				

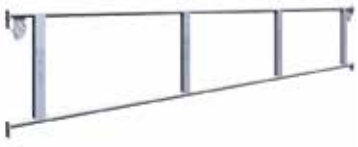
			Utför.	Art. nr	Vikt
TKS 750 Fackverk AL 2 st. skarvrör och 4 bult & mutter per fackverk		1250	AL	7570125	12,2
		2250	AL	7570225	21,2
		3250	AL	7570325	31,2
TKS 750 Fackverksvinkel		15,0°	AL	7570015	23,2
		22,5°	AL	7570025	19,6
		37,5°	AL	7570035	21,9
TKS 750 Skena Ände		0,62 m		7570005	2,2
TKS 750 Presenning trærulle 1 sæt				7570004	8,6
TKS 750 Fackversbalk Adapter				7570006	12,2
TKS 750 Beslag f.Adapter Används till 7570006 OBS 2 stk. klämbeslag				7570007	4,7
TKS 750 Klämbeslag f. Adapter				5231618	1,3
TKS 750 Packning				7570001	0,1
750 Skarvrör OBS mutter 6130588 och bult 6130587				7203001	2,0
Låssprint Diameter 12 mm resp. 16 mm		Låssprint 12	G	2113100	0,1
		Låssprint fjäder 16	G	2116000	0,2
Bult		HCB-bult 12x80	G	6130049	0,08
		R-Sprint	G	6130441	0,01
		Öglebult m mutter		7570003	1,00

		Utför.	Art. nr	Vikt
Skyddsräcksram GFL- Fzv	2500	G	7052254	9,2
Med fjäderlås 	3050	G	7052304	10,3
TKS 750 Räcke- Fzv	3050	G	7056301	7,1
Med fjäderlås 	2500	G	7056246	6,0
750 Diagonalstag AL	2500x2250	AL	4122253	5,1
Rördiameter 53 mm	2500x2000	AL	4122254	4,9
OBS! Normal rörkoppling 48 mm	3050x2000	AL	4122303	5,5
kan ej kopplas till röret 	3050x2250	AL	4122304	5,6
TKS DUK				
Färg på ficka HAKI standard				
L= 8000 Grå	8000x3050		2800300	9,3
L=10000 Vit	10000x3050		2800301	11,6
L=12000 Röd	12000x3050		2800302	13,9
L=14000 Blå	14000x3050		2800303	16,2
	8000x2500		2800359	13,6
	10000x2500		2800360	17,0
	12000x2500		2800361	20,4
	14000x2500		2800362	23,8
Spännrem				
2m - 400 kg.			7500050	0,1

HAKI Trak duk

PVC-belagd polyesterväv
Med kederlist
Konfektioneras från
fall till fall i längd och bredd



Offereras

HAKI Trak gavelkappa

Med kederlist på en sida
Bredd 935 mm
OBS! Täcker endast fackverk



Offereras

HAKITEC duk
HAKITEC

Armerad plastduk
Levereras på rulle



3300x36 m

2500300

38,0

HAKITEC flamhämmande

Armerad plastduk, flamhämmande, 200 g/m²
Vita strips, hål Ø 15 mm cc 0,1 m
Levereras på rulle



3250-36 m

2036041

23,4

Fasad Light 170

Armerad plastduk, 170 g/m²
Blå strips, hål Ø 15 mm cc 0,1 m
Levereras på rulle

3200-36 m

2037036

19,6

Fasadväv 50

Fasadväv, 50 g/m²
Leveras på rulle



3070-100 m

2031305

15,4

		Utför.	Art. nr	Vikt
Dukspännare	Dukspännare Light		2032300	0,01
Beräkna en dukspännare per 1,5 m ² täckande fasadyta Dukspännare förpackas 100 st/pkt				
Fästbalk- Fzv	950 23		7207095	5,0
Nyckelvidd 23 mm resp. 22 mm	950 22		7207096	5,0
	1900 23		7207190	8,0
	1900 22		7207191	8,0
Täckplåt HAKITEC- Fzv	Byggplåtskruv BTL 4,8x35		2114000	0,01
Beräkna 6 st byggplåtskruv per täckplåt samt 2 st per nockplåt Byggplåtskruv förpackas 250 st/pkt	Täckplåt 1900	G	7251200	3,3
	Nockplåt 15	G	7252001	0,8
Fallskyddsfäste- Fzv			7541010	10,0
För HAKITEC 750 med HAKITEC duk Med nockplåt 15°				

Ställningstak

		Utför.	Art. nr	Vikt
Ställningstak- Fzv	Takböj ställningstak	G	7014001	18,0
Takböj = fackbredd 700-770 mm	Förlängningsrör ställningstak	G	7014002	3,5
Takböj + 1 st Förl.rör = fackbredd 1050-1250 mm				
Takböj + 2 st Förl.rör = fackbredd 1655 mm				
Som dukstöd mellan takböjarna används Skyddsräcksram och Längdbalk				
Takböj ställningstak- Fzv		G	7014003	7,0
För montage direkt på en spirtopp Som förlängning används en spira, maximalt spira S 1000				



ÖVRIGT SORTIMENT





			Utför.	Art. nr	Vikt
Durkskena AL		1250	AL	4023120	4,1
		1655	AL	4023160	5,2
		1964	AL	4023190	6,0
		2500	AL	4023250	7,5
		3050	AL	4023300	9,0

Läktare

			Utför.	Art. nr	Vikt
Konsol- Fzv B=460 mm För montage på enrörsbalk ERB			G	7211002	3,4
Sidoräcke- Fzv		1050	G	7053100	15,0

HAKI Safety

			Utför.	Art. nr	Vikt
Universalfäste- Fzv Kan monteras både horisontellt och vertikalt Materialtjocklek 70 - 370 mm			G	7155141	8,1
Skruvfot- Fzv Med M16 skruv Skruven är utbyttbar			G	7155140	1,6

	Utför.	Art. nr	Vikt
Grindhållare SGF- Fzv För skyddsgrind med nät SGF Gör det möjligt att placera nästa spira på valfritt avstånd och i valfri riktning $\pm 45^\circ$		7053108	4,3
			
Räckeshållare GFL För skyddsräcksram GFL Gör det möjligt att placera nästa spira på valfritt avstånd och i valfri riktning $\pm 45^\circ$		7053109	1,8
			
Klämbeslag 500 Nyckelvidd 30 mm Monteras på plåtkant, tjocklek 15-35 mm	G	7215032	5,5
			
Vippesluss	3050	7059170	150,0
	2500	7059250	140,0

Register

450 Fackverksbalk	12
450 Fackverksbalk	41
450 Fackverksbalk m. byglar	12
450 Fackverksbalk m. byglar	41
450 Skarvrör	41
450 Skarvrör takfot	41
450 Takfotsbeslag	41
450 Väggestolpe	42
750 Bottenram	44
750 Diagonalstag	43
750 Dragok	45
750 Duksträckare	45
750 Duksträckarrör	45
750 Fackverk	11
750 Fackverk	45
750 Fackverk stål	11
750 Fackverksupplag	44
750 Fackverksupplag kompakt	44
750 Fackverksvinkel	43
750 Fallskyddsfäste	46
750 Fallskyddsfäste Trak	46
750 Fasthjul med spår	44
750 Koppling variabel SW	44
750 Krok lyftsäkring	44
750 Nockrulle med ram	45
750 Rullkonsol	46
750 Räckestolpe	44
750 Rälkoppling	45
750 Skarvdel stål	11
750 Skarvdon	47
750 Skarvpackning	47
750 Skarvpinne	47
750 Skarvrör	43
750 Skena	46
750 Skena nock	46
750 Skena takfot	46
750 Skenfäste	47
750 Skenfäste takfot	47
750 Spännband	47
750 Triangelbalk	45
Adapter fackverksbalk	12
Adaptor Tripod	19
AL plank B=200 mm	7
AL plank B=230 mm	7
AL plank B=320 mm	8
AL plank B=295 mm	8

AL plank B=320 mm	32
Balkryttare	16
Balkryttare	23
Belysningskonsol	33
Beslag skjutbar grind	17
Bottenskruv	3
Bottenskruv	34
Bottenskruv 60	19
Bottenskruv ledad 750	3
Bottenskruv S6	24
Bult	43
Bygelgrupp	33
Bygelgrupp lös	16
Bygelgrupp lös	37
Diagonalstag AL	22
Diagonalstag DS	5
Dukspännare	51
Durkskena AL	53
Enkelbalk	15
Enrörsbalk	4
Enrörsbalk AL	21
Fackverksbalk	11
Fallskyddsfäste	46
Fasad Light 170	50
Fasadväv 50	50
Fotlist	9
Fotlist	36
Fotlistbeslag	9
Fotlistbeslag	36
Fästbalk	51
Grindhållare SGF	54
HAKI Galge	19
HAKI Stålp plank B=230 mm	8
HAKI Säkerhetsblock	19
Hakitainer	19
HAKITEC	50
HAKITEC flamhämmande	50
HAKI Trak duk	50
HAKI Trak gavelkappa	50
HBS Diagonalstag	30
HBS Enrörsbalk med skruvlås SBF	30
HBS Horisontalstag	30
HBS H-Profil inklädnadspanel	31
HBS Inklädnadspanel	31
HBS Låsklämma inklädnadspanel	31
HBS Nedre Balk	30
HBS Pelare	30

HBS Sprint	31
HBS Tripod Toppadapter inkl. klämbeslag	31
HBS Tårplåtsplank	29
HBS U-Profil inklädnadspanel	29
HBS Övre Balk	30
Horisontalstag HDS	5
Horisontalstag HDS	22
Horisontalstag teleskopiskt HDS	22
Hylsnyckel	40
Höjdinställningsspira	15
Instegstrappa	13
Klämbeslag 500	14
Kombinationsbeslag	17
Konsol	10
Konsol AL	23
Konsol AL	24
Konsol	36
Konsol justerbar	10
Konsol med spirskarv	10
Konsol med spirskarv S4 AL	23
Konsol med spirskarv S6 AL	24
Konsol utan spirskarv	10
Koppling fast	33
Koppling fast	40
Koppling variabel	40
Krokplan B=400 mm	6
Krokplan B=600 mm	6
Krokplan med lucka B=600 mm	7
Krokplan med lucka och stege	7
L-ram	34
Låsbalk	37
Låsbeslag trall	6
Låsfjäder bottenskruv	3
Låsklammer skyddsräck	16
Låsklammer skyddsräck	37
Låskrok	37
Låssprint	43
Längdbalk	3
Längdbalk	21
Länkhjul	18
Länkhjul S6	25
Markram	37
Mellanspira	15
Monteringsverktyg	20
Monteringsverktyg fjäderlås	20
Motvikt	33
PAS Bottenstag Vangstycke	29

PAS Enrörsbalk m täckplåt	28
PAS Handledare	28
PAS Handledare insteg	28
PAS Handledare Tripod	29
PAS/HBS Tårplåtsplank	29
PAS/HBS Tårplåtsplank Toppsteg	29
PAS Skyddsräcke	28
PAS Tårplåtsplank	29
PAS Tårplåtsplank Insteg	29
PAS Vangstycke	29
PAS Vangstycke insteg	29
Plan B=310 mm	35
Plan B=620 mm	35
Plankryttare	18
Ram 500	34
Ram 500 AL	38
Ram 800	34
Ram 800 AL	38
Ram 1000	34
Ram 1000 AL	38
Ram 2000	34
Ram 2000 AL	38
Ram med fotlist	34
Ram med fotlist	38
Ramplan med lucka	35
Ramtainer	37
Räcke stolpe	17
Räcke stolpe SRS	16
Räcke stolpe SS	16
Sidoräcke	53
Skenfäste koppling	47
Skruvfot	53
Skyddsståg	17
Skyddsgrind	54
Skyddsgrind med nät SGF	5
Skyddsräcksram	4
Skyddsräcksram AL	22
Skyddsräcksram	35
Skyddsräcksram för trätrall GFLH	4
Skyddsräcksram GFL	4
Skyddstakskonsol	17
Skyttklammer	33
Spira S	3
Spira S4 AL	21
Spira S6 AL	24
Spira S6 AL med sprint	24
Spirhållare	15

Spirhållare S4 AL	23
Spirhållare S6 AL	25
Sprint till spirskarv	3
Sprint till spirskarv	21
Spännband	45
SS Klämbeslag	14
SS Montagestag	14
SS Upphängningsbeslag Bulb-Kätting	14
SS Upphängningsbeslag Bulb-Kätting	14
SS Upphängningsbeslag Bulb-Rör	14
SS Upphängningsbeslag Gallerdurk	14
SS Upphängningsbeslag H-balk	14
SS Upphängningsbeslag KF 48 dubbel	14
SS Upphängningsbeslag Kätting	14
SS Upphängningsbeslag L-balk	14
STS Fotlist	27
Stege ST	7
Stege ST	36
STS Handledare	26
STS Instegstrappa	27
STS Ledstångsstolpe	26
STS Ledstångsstolpe kil	26
STS Låskrok	27
STS Skyddsgrind	26
STS Skyddsgrind	27
STS Skyddsräcksram	27
STS Trapplöp	26
STS Vilplan	26
STV Stege med vilplan	13
Styrning Trak duk	47
Ståltrall	8
Ställningsbock	19
Ställningsnyckel	20
Ställningsnyckel	40
Ställningsrör	40
Ställningsskylt	20
Ställningstak	51
Stödben	18
Takböj ställningstak	51
Toppklykor	18
Topplatta Tripod	19
Toppspira SC	3
Trall	6
Trall AL	6
Trall Komposit	6
Tripod	19
Tvärbalk	15

Tvärprofil	37
Täckplåt AL	17
Täckplåt HAKITEC	51
Täckplåt UTV AL/Ramplan	37
Universalfäste	53
Upplagsbalk	37
U-profil lyftsäkring	44
UTV Handledare inre	13
UTV Trappa	13
UTV Trappa	36
UTV Trappa AL	13
UTV Trappa AL	36
Väggfästestag rör	5
Väggfästestag rör	35
Väggstag VST	5
Övriga kopplingar	40
Övrigt sortiment	52

